

Previously:

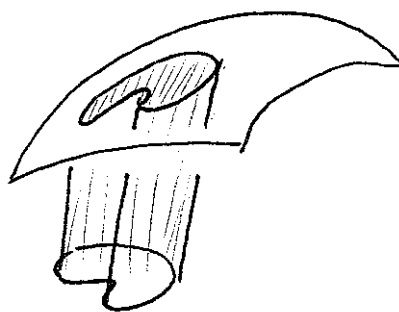

Region in \mathbb{R}^2
 $f: \mathbb{R}^2 \rightarrow \mathbb{R}$



$$\iint_R f \, dA$$

Volume of

$$\iint_R 1 \, dA = \text{Area of } R$$

$$\frac{1}{\text{Area}} \iint_R f \, dA = \text{Average of } f \text{ on } R.$$

[Also total mass, center of mass, etc...]

Triple Ints: R a region in \mathbb{R}^3

$$f: \mathbb{R}^3 \rightarrow \mathbb{R}$$

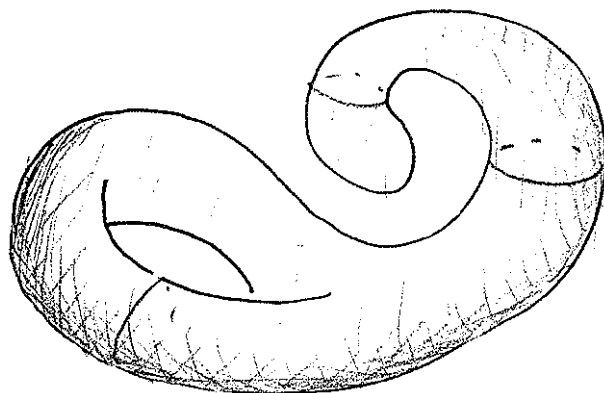
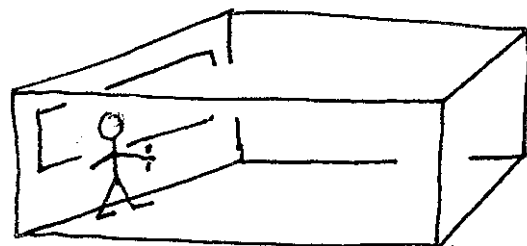

$$\iiint_R f(x,y,z) \, dV$$

$$\iiint_R 1 \, dV = \text{Volume}$$

$$\text{Average} = \frac{1}{\text{Vol}} \iiint_R f \, dV$$

$$\text{Mass} = \iiint_R \underbrace{\rho(x,y,z)}_{\text{density}} \, dV$$

As always, defined math. in terms of certain Riemann sums...

Ex:

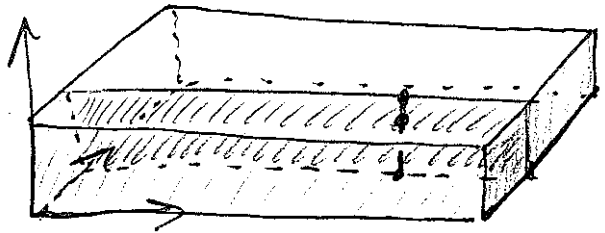

$$0 \leq x \leq 3$$

$$0 \leq y \leq 2$$

$$0 \leq z \leq 1$$

First slice by y, then x then z.

$$\iiint_R f \, dV = \int_0^2 \int_0^3 \int_0^1 xy+z \, dz \, dx \, dy$$

$$= \dots = 12.$$

$$f(x,y,z) = xy+z$$

Just like double ints

[Of course, you'd get the same answer any of the other five ways.]

Ex: Volume of unit sphere $x^2+y^2+z^2=1$.

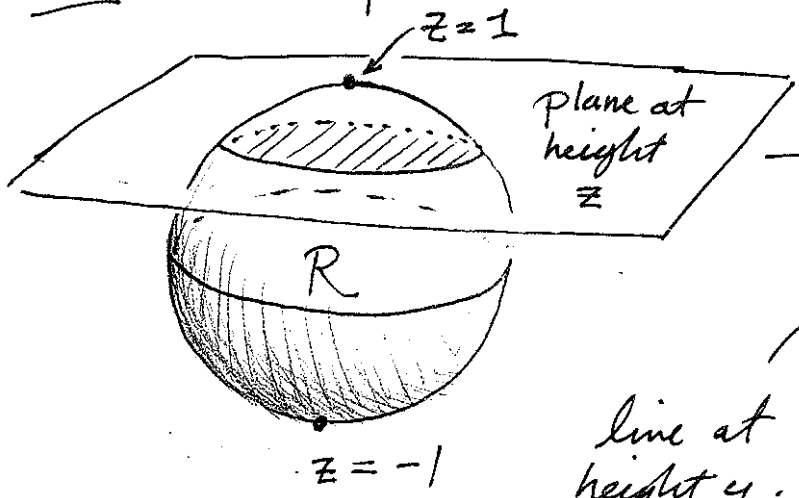

plane at height z

line at height y.

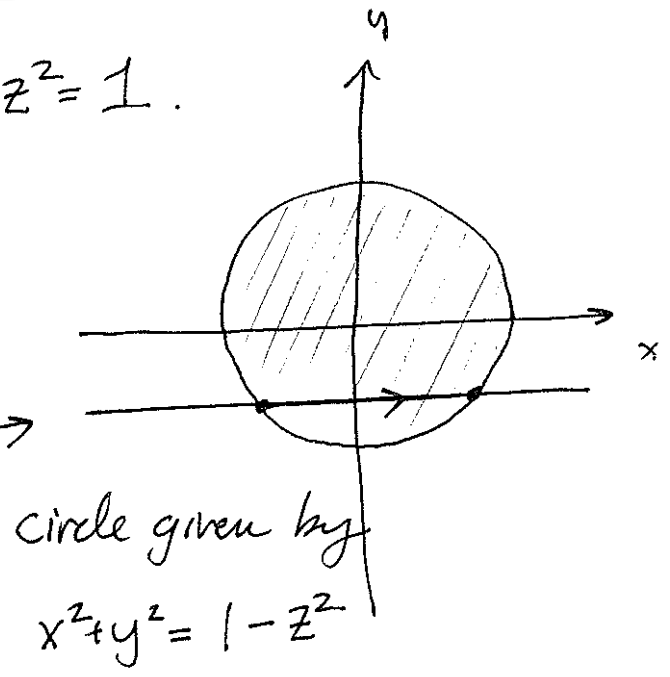

circle given by $x^2+y^2=1-z^2$

y goes from $-\sqrt{1-z^2}$ to $\sqrt{1-z^2}$

x goes from $-\sqrt{1-y^2-z^2}$ to $\sqrt{1-y^2-z^2}$

$$\iiint_R 1 \, dV = \int_{-1}^1 \int_{-\sqrt{1-z^2}}^{\sqrt{1-z^2}} \int_{-\sqrt{1-y^2-z^2}}^{\sqrt{1-y^2-z^2}} 1 \, dx \, dy \, dz \quad \underline{84}$$

Can do with trig substitution / table

Or note that it is the area of a disc of radius $\sqrt{1-z^2}$

$$= \int_{-1}^1 \pi(1-z^2) \, dz = \pi \left(z - \frac{z^3}{3} \right) \Big|_{z=-1}^1$$

$$= \pi \left((1 - \frac{1}{3}) - (-1 + \frac{1}{3}) \right) = \frac{4}{3} \pi.$$

Cf Archimedes.

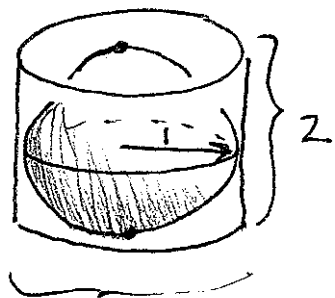

$$\text{So } \frac{\text{Vol}(\text{Cylinder})}{\text{Vol}(\text{Sphere})} = \frac{3}{2}$$

Base area = π

$$\Rightarrow \text{Vol}(\text{Cylinder}) = 2\pi$$

Ex: Consider the region in the pos octant bounded by the planes $x=0$, $y=0$, $z=2$ and the surface $z = x^2 + y^2$.

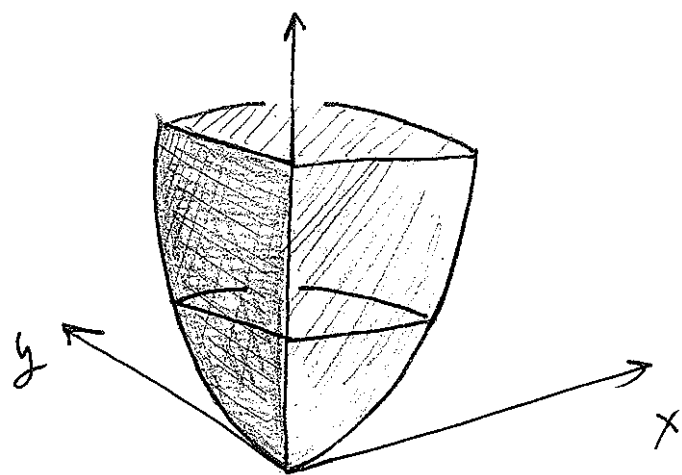

Slice by planes of fixed z -height to get

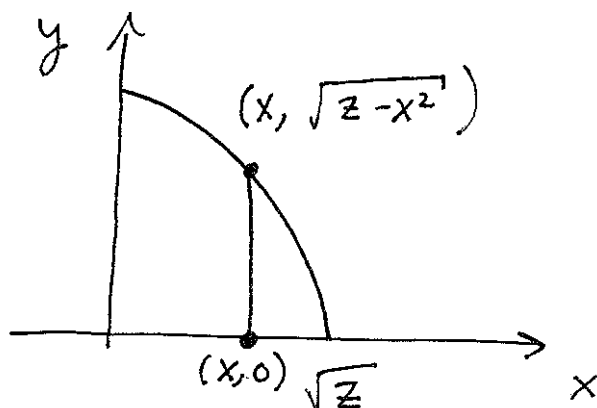

$$\iiint_R f \, dV = \int_0^2 \int_0^{\sqrt{z}} \int_0^{\sqrt{z-x^2}} f(x, y, z) \, dy \, dx \, dz$$

Alternate coordinates: (15.7 and 15.8)

Cylindrical:

$$(r, \theta, z) \longleftrightarrow \begin{matrix} x & y & z \\ (r \cos \theta, r \sin \theta, z) \end{matrix}$$

$$0 \leq r$$

$$0 \leq \theta \leq 2\pi$$

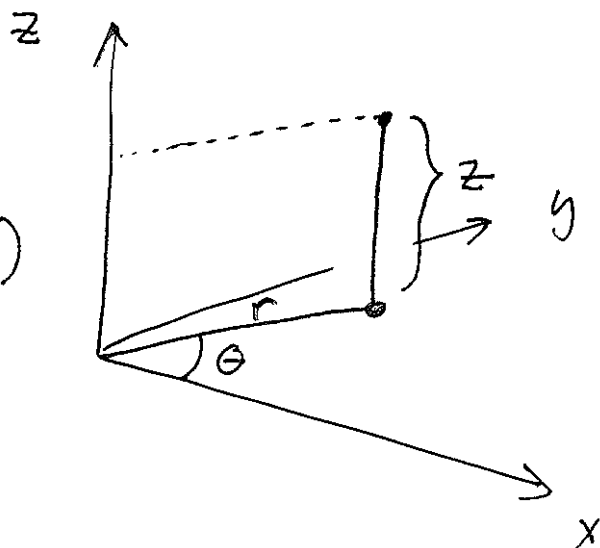

Typical use:

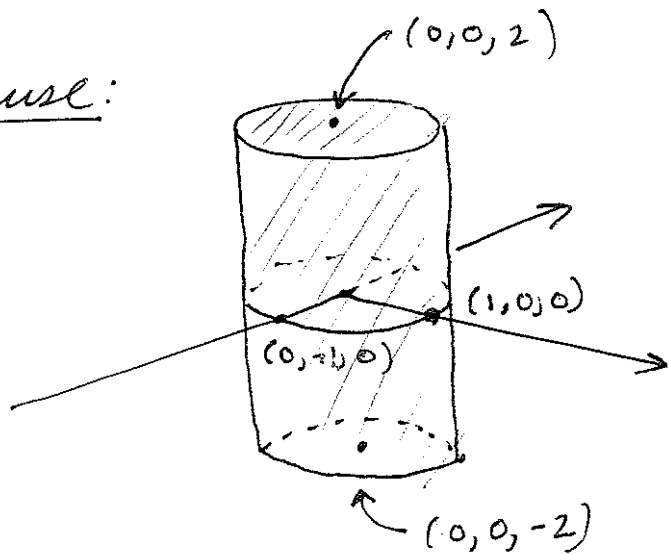

Rectangular

$$-2 \leq z \leq 2$$

$$x^2 + y^2 \leq 1$$

Cylindrical:

$$0 \leq r \leq 1$$

$$0 \leq \theta \leq 2\pi$$

$$-2 \leq z \leq 2.$$

Spherical:

$$0 \leq \rho$$

$$0 \leq \theta \leq 2\pi$$

$$0 \leq \phi \leq \pi$$

$$x = \rho \sin \phi \cos \theta$$

$$y = \rho \sin \phi \sin \theta$$

$$z = \rho \cos \phi \leftarrow \text{start here.}$$

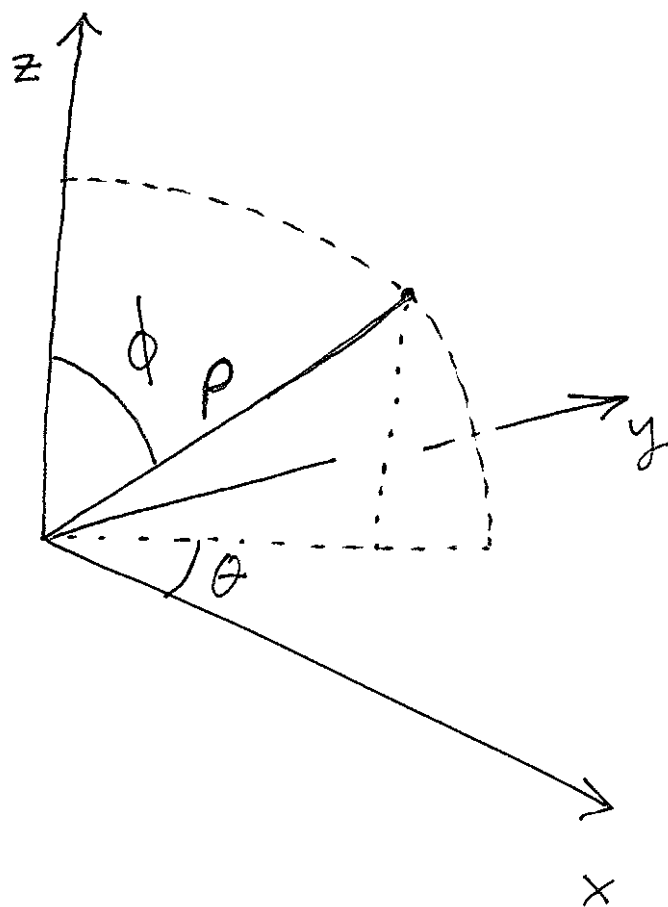

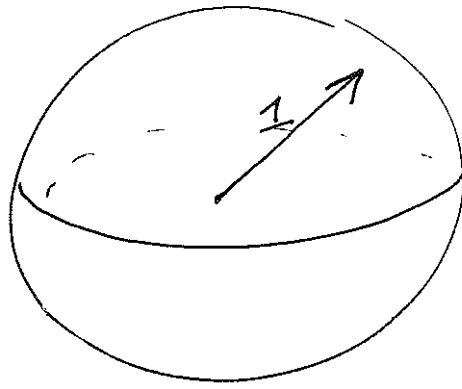

Rectangular:

$$-1 \leq z \leq 1$$

$$-\sqrt{1-z^2} \leq y \leq \sqrt{1-z^2}$$

$$-\sqrt{1-y^2-z^2} \leq x \leq \sqrt{1-y^2-z^2}$$

Cylindrical:

$$-1 \leq z \leq 1$$

$$0 \leq r \leq \sqrt{1-z^2}$$

$$0 \leq \theta \leq 2\pi$$

Spherical:

$$0 \leq \rho \leq 1$$

$$0 \leq \theta \leq 2\pi$$

$$0 \leq \phi \leq \pi$$

Q: How do we integrate in these different coordinates?